

## 300.10.10 / 300.10.11 / 300.10.12 / 300.10.13 LED Illuminated Mirror

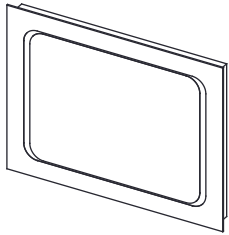

300.10.10

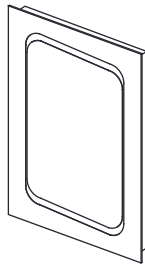

300.10.11

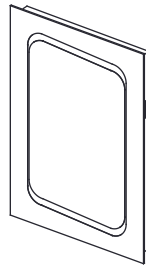

300.10.12

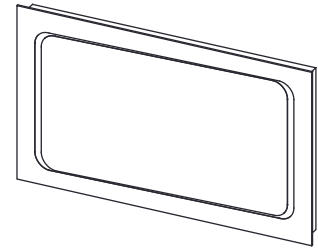

300.10.13

Thank you for purchasing our product.

Please read through these instructions carefully and refer back to them during installation to ensure that your product is fitted safely and that it retains its high quality finish.

Please retain it for future reference.

**Handle with care! When unpacked, never place upright on a hard surface eg. Tile Floor. Always lay on soft surface.**



**To avoid the risk of electrocution, please turn off the electricity mains supply before commencing the installation.**

**Please do not hang or drape any clothes or material on the mirrors as the bulbs get very hot and this will cause a fire!**

**Please also do not place objects too close to the bulbs as this will cause them to burn or melt the object!**

1.

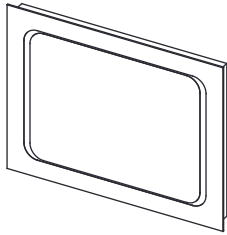

1X

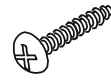

4X



4X

2.

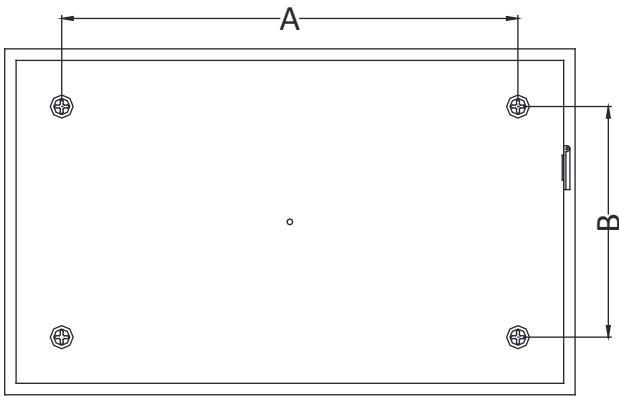

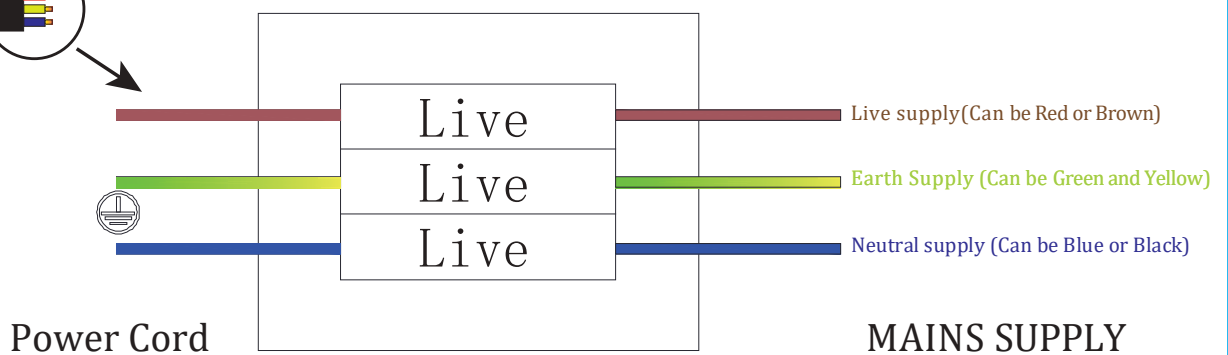

Art No	Distance	A(mm)	B(mm)
<b>300.10.10</b>		600	400
<b>300.10.11</b>		280	480
<b>300.10.12</b>		280	480
<b>300.10.13</b>		800	400

3.

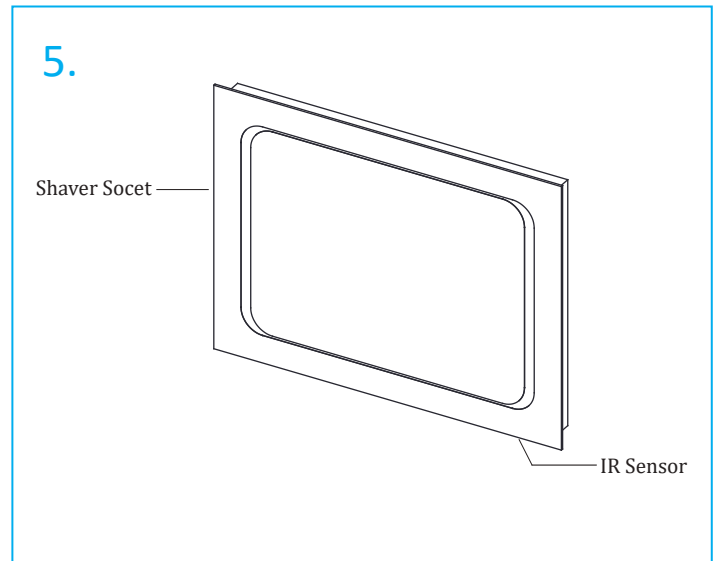
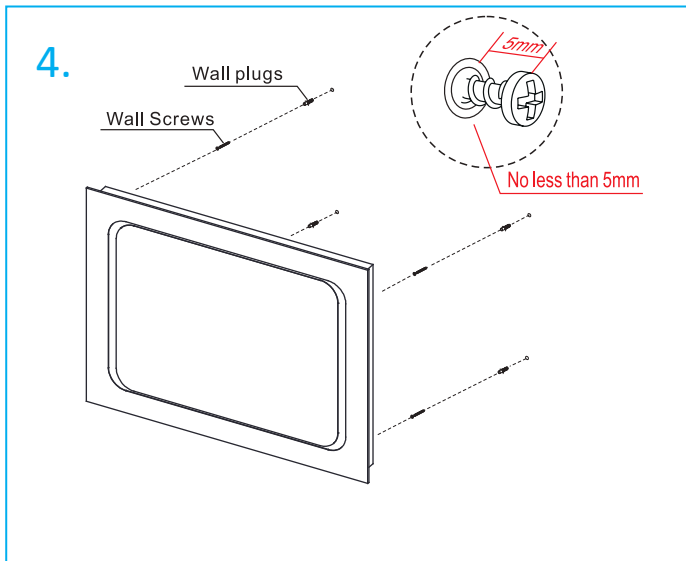

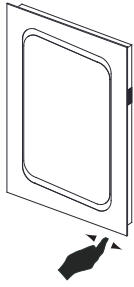

1. Open the carton and make sure all the parts listed below are present.
2. Mark a desired height of the mirror. Drill the required holes and insert the wall plugs.  
Note: Wall plugs supplied are only suitable for solid stone/brick walls. Please ensure the screws are fully tight. The rectangular mirror can be mounted either portrait or landscape.
3. Make the electrical connections ensuring first that the electrical supply has been turned off. This mirror is a class 1 product and requires an earth connection. It should be installed in accordance with the latest IEE regulations.
4. Secure the mirror.

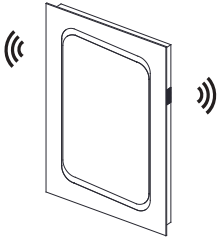
<p>1. Leila 300.10.12</p>  <p>To activate the Bluetooth®, operate the sensor switch located at the bottom of the mirror. The mirror will give out a tone to confirm it is ready for pairing.</p>	<p>2.</p>  <p>Activate the Bluetooth® on your device*</p>	<p>3.</p> 	<p>4.</p>  <p>You can now listen to your favorite song or on line radio station via the stereo speakers</p>
---	--	--	--

- When the mirror is turned off the connection to the Bluetooth® will be lost. When the mirror is turned on again it will automatically reconnect to the last connected device.

- Refer to your device manual for operating controls.

- Music will stop playing when a phone call comes into the Bluetooth® device, and will automatically reconnect when finished.

### Trouble Shooting Guide

symptoms	possible problem	solution
Device not paired	Bluetooth® not activated	Check Bluetooth® is activated on compatible device & mirror is turned on
Device not connecting	Only one device can be connected to the mirror at any one time	Disconnect all devices and reconnect only one device
No volume	Volume is controlled from device	Increase volume on device
No connection	Out of range	Range is within 8 metres, move device closer to mirror