

Savannah- LED Illuminated Mirror

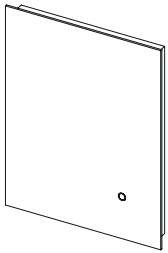

Savannah 500.40.90

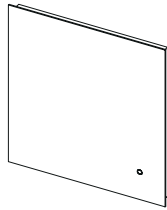

Savannah 500.40.91

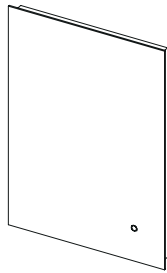

Savannah 500.40.92

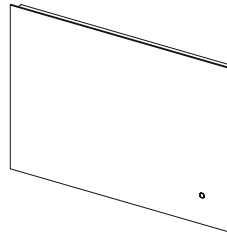

Savannah 500.40.93

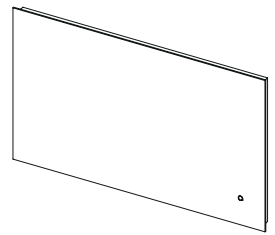

Savannah 500.40.94

Thank you for purchasing our product.

Please read through these instructions carefully and refer back to them during installation to ensure that your product is fitted safely and that it retains its high quality finish.

Please retain it for future reference.

Handle with care! When unpacked, never place upright on a hard surface eg. Tile Floor. Always lay on soft surface.



To avoid the risk of electrocution, please turn off the electricity mains supply before commencing the installation.

Please do not hang or drape any clothes or material on the mirrors as the bulbs get very hot and this will cause a fire!

Please also do not place objects too close to the bulbs as this will cause them to burn or melt the object!

1.

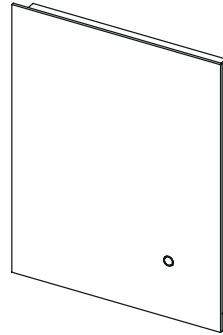

1X



2X



2X

2.

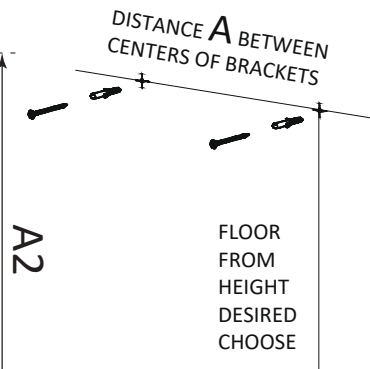
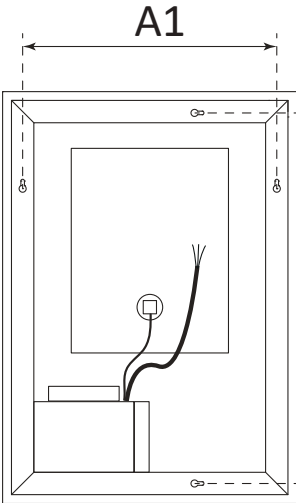

Art No	Distance	A1(mm)	A2(mm)
500.40.90		322	432
500.40.91		532	532
500.40.92		432	632
500.40.93		732	532
500.40.94		932	532

3.

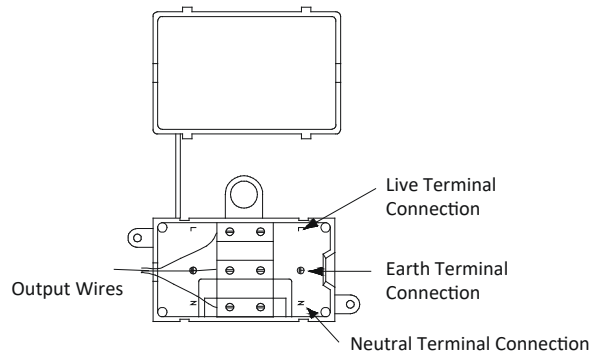
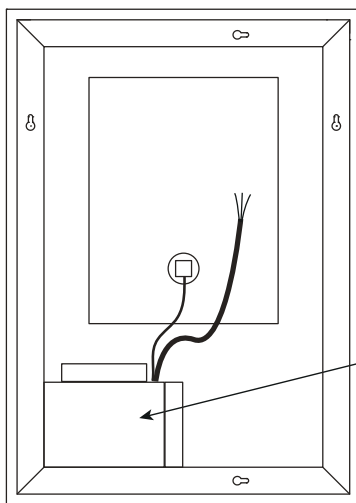

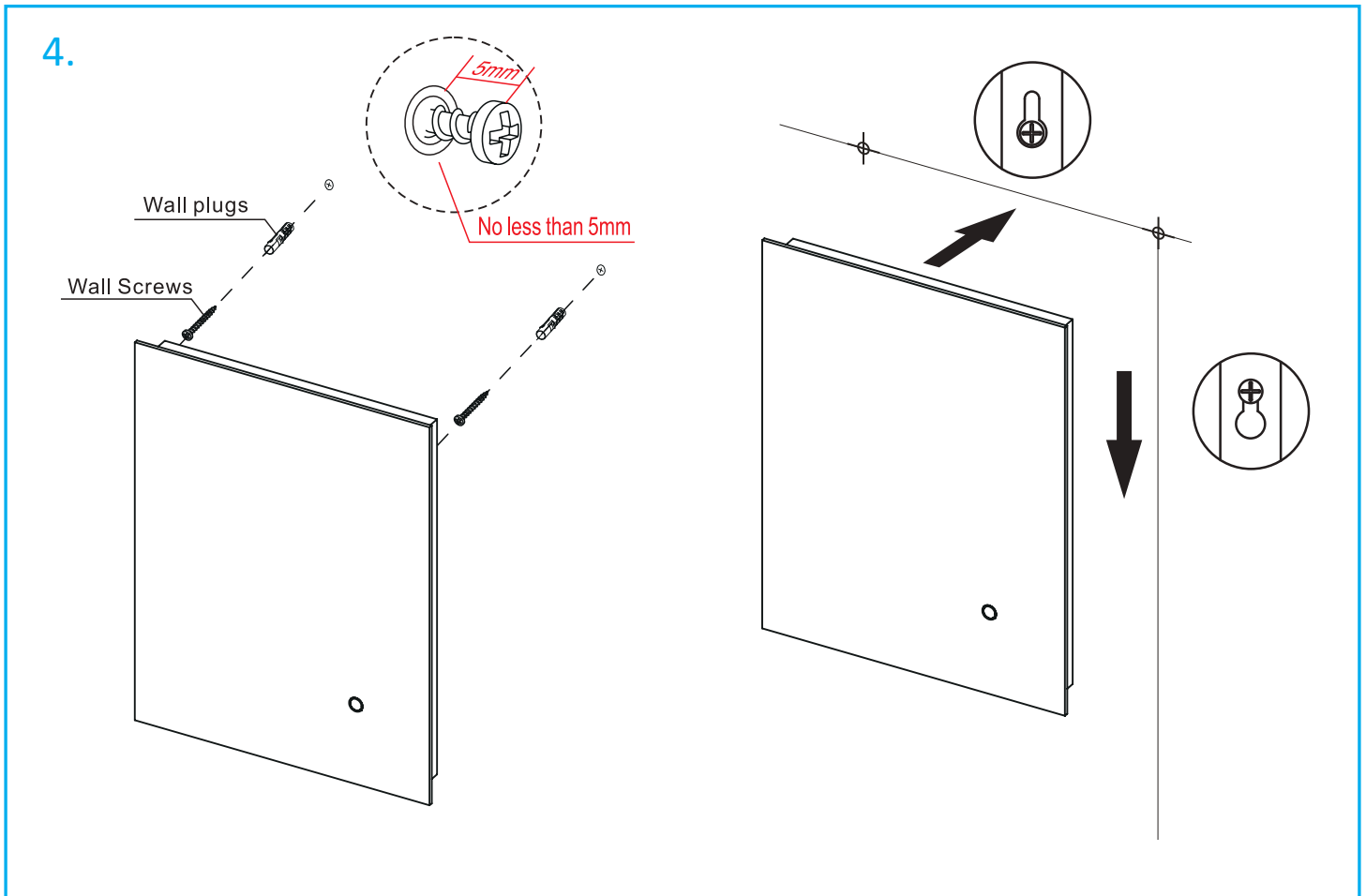

1. Open the carton and make sure all the parts listed below are present
2. Mark a desired height of the mirror. Drill the required holes and insert the wall plugs.
Note: Wall plugs supplied are only suitable for solid stone/brick walls. Please ensure the screws are fully tight. The mirror can be mounted either portrait or landscape.
3. Make the electrical connections ensuring first that the electrical supply has been turned off. This mirror is a class 1 product and requires an earth connection. It should be installed in accordance with the latest IEE regulations.
4. Hang the mirror onto the wall.